

Assembly Instructions & User's Manual
for
Abbyson Elliot Fabric Reversible Sofa Chaise Sectional

Item Number: XXXXXXXXXXXX

Model Number: SHF-3450-SNDI

**Abbyson Customer Experience Team (spare/replacement parts): 1-888-406-0838
or Email: samsclub@abbysonliving.com**

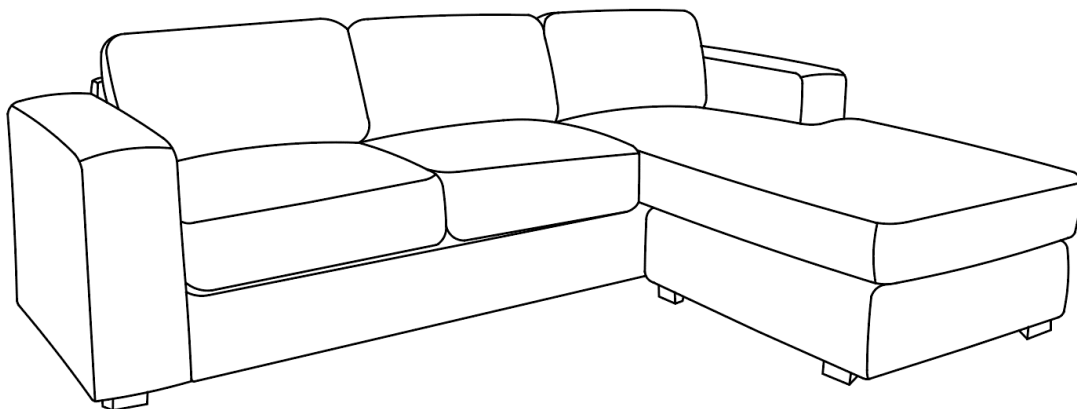
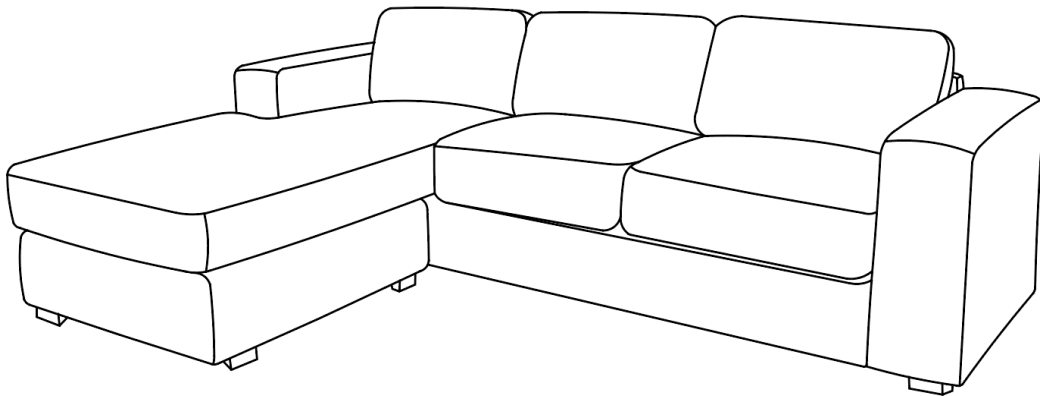

THIS ASSEMBLY MANUAL CONTAINS IMPORTANT SAFETY INFORMATION.
PLEASE READ AND KEEP FOR FUTURE REFERENCE.

Table of Contents

Important Safety Information	3
Before Assembly	3
Care & Use	3
Package Contents	4
Product Information	4
Components	5
Hardware	5
Tools	5
Step 1	6
Step 2	6
Step 3	7
 Warning	8
Troubleshooting	8
Care & Use Instructions	8
Storage Instructions	8
Warranty Information	9

Important Safety Information

- *Please read all instructions carefully before assembling this product.*
- *Where applicable, and for your safety, assembly by an adult is strongly recommended.*
- *Use only vendor-supplied hardware to assemble this item. Using unauthorized hardware could jeopardize the structural integrity of the item.*
- *Hardware may loosen overtime. Periodically check that all connections are tight.*
- *Keep small parts and hardware out of the reach of children.*
- *Keep instructions for future use.*

Before Assembly

- *Remove all parts and hardware from the box. Place all items on a carpeted or scratch-free work surface, as this will avoid damaging parts during assembly.*
- *The shipping box can provide an ideal work surface if none is available.*
- *Use the components and hardware lists below to identify, inventory and separate each of the hardware and components included.*
- *To avoid accidentally discarding small components or hardware, do not dispose of any packaging or contents of the shipping carton until assembly is complete.*
- **DO NOT USE** *power tools unless it is explicitly identified in this manual as required for use during assembly. Power tools can damage the fasteners, hardware and/or components.*
- *Do not fully tighten all fasteners/screws until all parts are in place. Failure to follow these instructions may cause the fasteners/screws to misalign during assembly.*

Care & Use

- *Use a soft, clean cloth that will not scratch the surface when cleaning.*
- *Be sure to vacuum on a weekly basis so dust and dirt do not settle into the fabric.*
- *Wrinkles in the fabric are a natural part of normal wear.*
- *Fabric can fade when exposed to direct sunlight over a long period of time.*
- *To minimize fading, avoid placing your furniture in direct sunlight.*
- *Avoid cleaners that use chemical products. Many of these are harsh and not safe for use on upholstery.*
- *Stress to the fabric may result in tears and when stretched, upholstery may not completely return to its original shape.*
- *Avoid sitting in one area and use the seating areas evenly for even wear.*
- *Fabric is not resistant to animals. Allowing pets on your upholstered furniture is not recommended.*
- *If pillow cushions are sewn to the frame, any pulling, or tugging may result in a tear.*

Package Contents

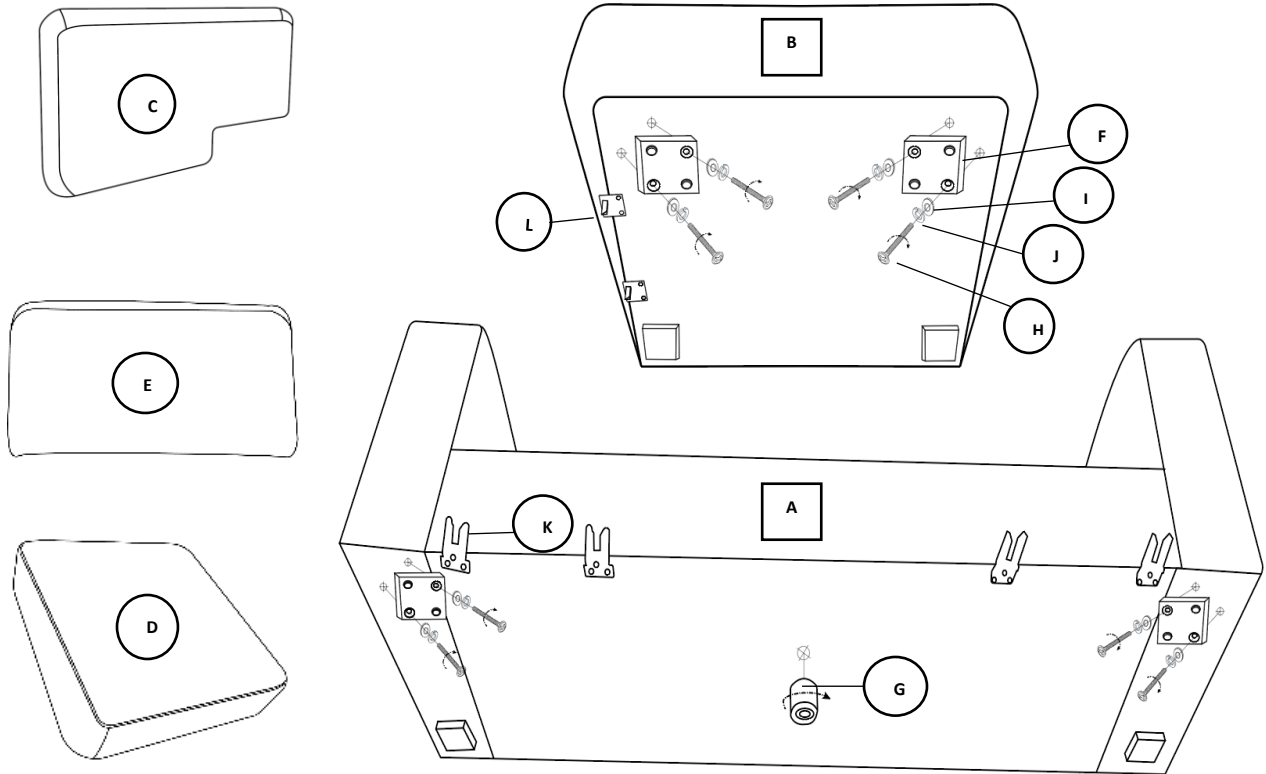

Component	Description	Qty	Component	Description	Qty
A	Sofa Base	1	G	Support Leg (60*45MM)	1
B	Chaise Ottoman	1	H	Phillips Head Bolts (Φ12 M6 x 50MM)	16
C	Loose Chaise Cushion	1	I	Spring Washer	16
D	Sofa Seat Cushions	2	J	Flat Washer	16
E	Sofa Back Cushions	3	K	Alligator Snap Bracket - Teeth	4
F	Wood Legs (145*145* 45MM)	8	L	Alligator Snap Bracket - Pin	2







Product Information

Overall Product Dimensions: 85" x 59" x 36" (215.9cm x 149.86cm x 91.44cm)

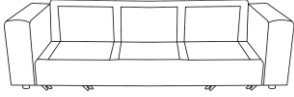

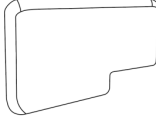
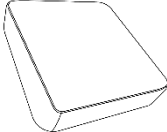

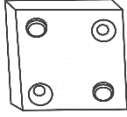
Product Weight Capacity: Supports up to 250 lbs. per seat (635 kg.)

Sectional can be assembled with either a left facing chaise or a right facing chaise. See instructions below.

Components

<p>Seat Base (A) Part No. SHF-3450-SNDI-SB Qty: 1</p> 	<p>Chaise Ottoman (B) Part No. SHF-3450-SNDI-CO Qty: 1</p> 	<p>Loose Chaise Cushions (C) Part No. SHF-3450-SNDI-CC Qty: 1</p> 
<p>Seat Cushion (D) Part No. SHF-3450-SNDI-SC Qty: 2</p> 	<p>Back Cushion (E) Part No. SHF-3450-SNDI-BC Qty: 3</p> 	<p>Wooden Leg (F) Part No. WD-S1-0007 Qty: 8</p> 
<p>Support Legs (G) Part No. WD-S1-0020 Qty: 1</p> 		

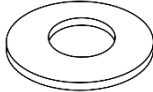
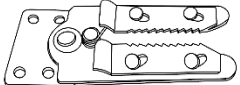
Hardware

<p>Phillips Head Bolts (H) Part No. HW-08-0006 Qty: 16</p> 	<p>Spring Washer (I) Part No. HW-09-0008 Qty: 16</p> 	<p>Flat Washer (J) Part No. HW-09-0001 Qty: 16</p> 
<p>Alligator Snap Bracket - Teeth (K) (Pre-installed) Part No. HW-12-0008 Qty: 4</p> 	<p>Alligator Snap Bracket - Pin (L) (Pre-installed) Part No. HW-12-0009 Qty: 2</p> 	

Tools

<p>Phillips Screwdriver (NOT included)</p> 		

Step 1

Unpack the legs, bolts, and washers from the base cloth zipper as shown in drawing.

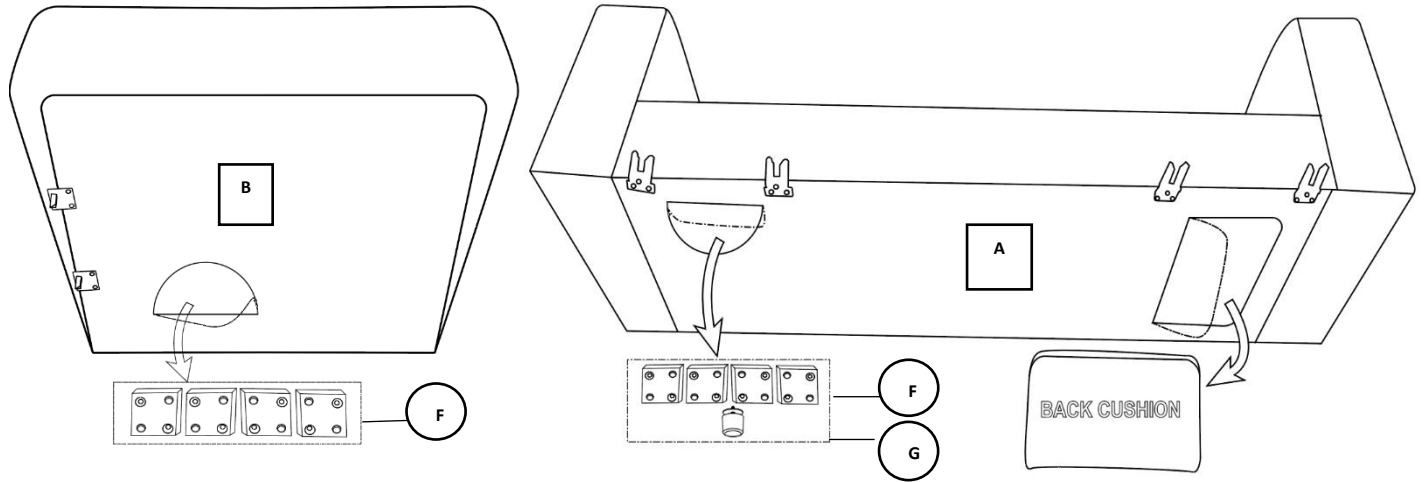

Step 2

Install wooden legs by screwing the legs in the location detailed in the diagram below by using a screwdriver. Hand screw middle support leg.

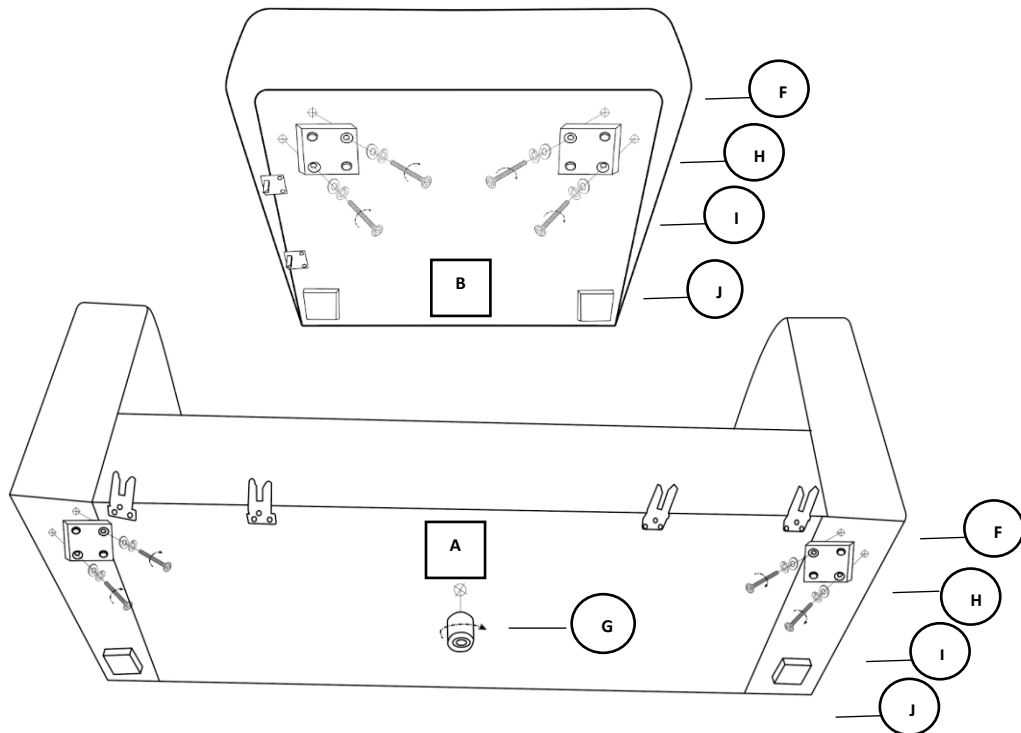

Step 3

To join sofa and ottoman chaise together – connect metal pins from the chaise into sofa snap brackets. Brackets and clips have been preinstalled for the chaise to be RIGHT (Configuration #1) or LEFT (Configuration #2) side of reversible sectional. Metal snap interlocking clip.

Configuration #1:

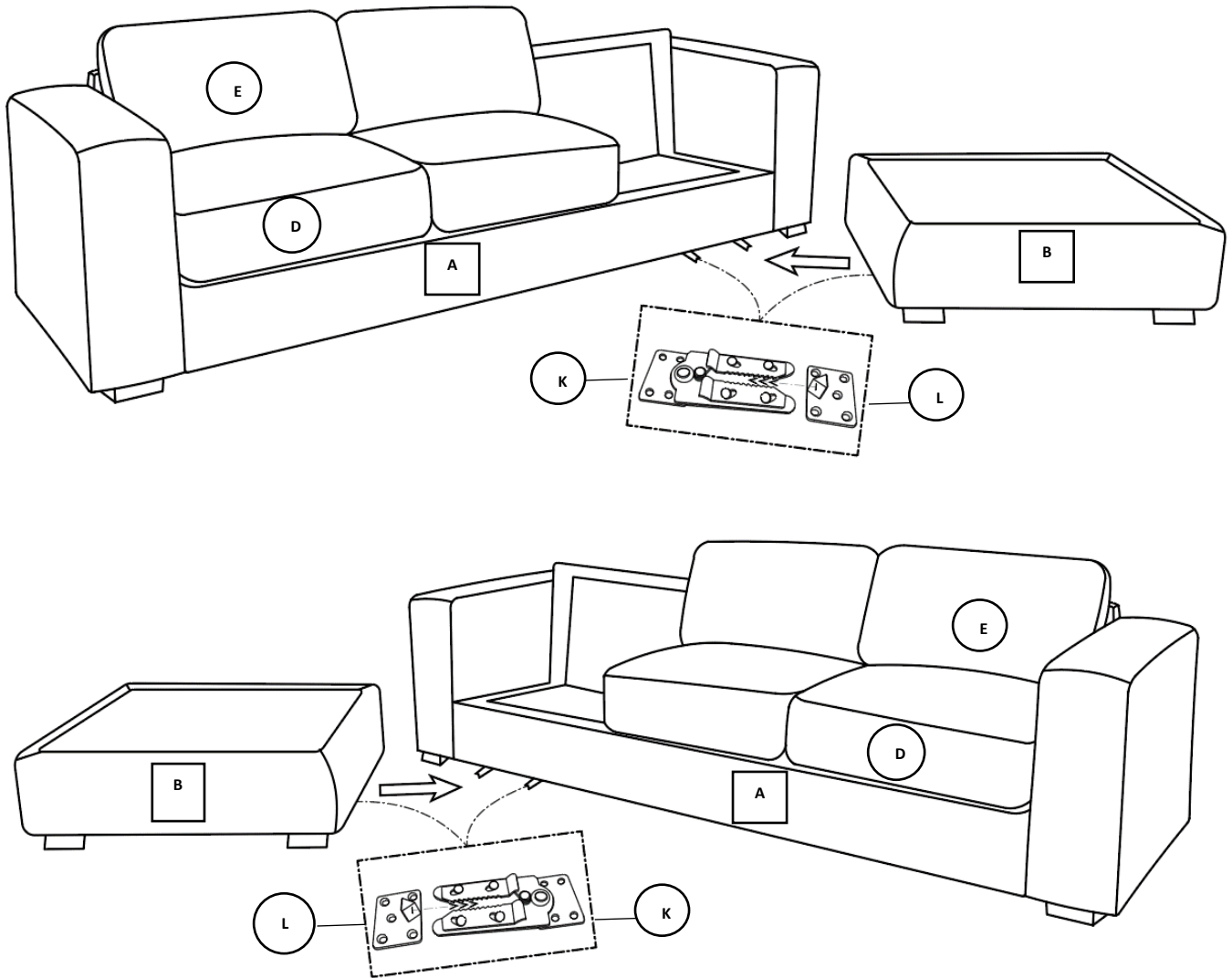



Warning

- Do not use this product unless all screws and bolts are securely tightened.
- Check that all screws and bolts are secure every three months or as needed.
- Dispose of packing material properly. Do not use plastic cover as head covering as it may cause suffocation.
- Do not use this product as a stepladder.
- Use this product for intended purpose only.
- Intended for residential use only.

Troubleshooting

Problem	Possible Cause	Prevention / Solution
Tilting/Leaning	Surface not level	Check all screws and bolts are secure until level

Care & Use Instructions

Care	Use a soft untreated cloth or vacuum regularly - avoid using detergents or chemical cleaners. Clean up spills immediately. Use a blotting rather than a wiping action.
Use	Avoid placing furniture in direct sunlight. Avoid extreme changes in temperature by arranging furniture away from radiators, heat, and air conditioning units. Protect furniture from animals. Fabric is not resistant to animal stains.

Storage Instructions

Item XXX	<ol style="list-style-type: none">1. Carefully place all components into shipping box and/or provided container tape it shut.2. When not in use, please store your item in a cool, dry place away from sunlight.3. Exposing your item to excessive heat or humidity may damage your item.
----------	---

Warranty Information

Warranty

This product is covered by the Sam's Club Member Satisfaction Guarantee. Please visit samsclub.com for more information.

This product's components have a 1-year guarantee against defects in material and/or workmanship. If you have any questions regarding the warranty or spare / replacement parts, please call our toll-free number 1-800-406-0838 or email us at samsclub@abbysonliving.com

NOTE: Please consider recycling all applicable packaging material.

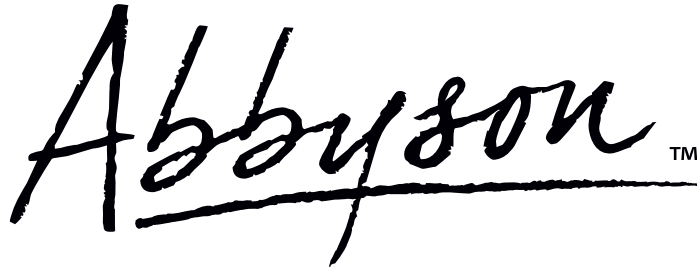
The logo for Abbyson is written in a black, cursive script. The word "Abbyson" is written in a fluid, handwritten style. A horizontal line is drawn underneath the word, starting from the left and extending past the end of the word. To the right of the word, above the line, is a small "TM" trademark symbol.