

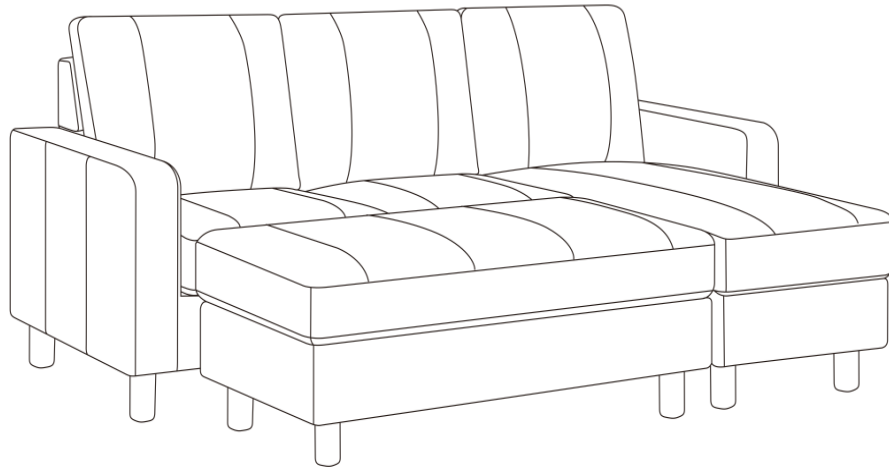

**Berkeley Fabric Reversible Sectional
MB-298-SEC**

ASSEMBLY INSTRUCTIONS



Est. Assembly Time: 15 minutes



Number of People: 2

Date: 17/10/2023

Page 1 / 7

For assistance with assembly or customer service, please contact the Abbyson Customer Experience Team
support@abbysonliving.com | Toll Free at 1-888-406-0838

www.abbyson.com

IMPORTANT SAFETY INSTRUCTIONS:

- Read all instructions carefully before unpacking assembly parts. Sharp, exposed staple tips can cause injury. For your protection, please remove any exposed staples used in packing.
- For your safety, assembly by two or more adults is recommended.
- Use only vendor supplied hardware to assemble. Using unauthorized hardware could jeopardize the structural integrity of the item.
- Keep instructions for future use.
- Intended for residential use only.
- Keep small parts and hardware out of the reach of children.







PRE-ASSEMBLY INSTRUCTIONS:

- Remove all parts and hardware from the box and place them on a carpeted or scratch-free work surface.
- To avoid accidentally discarding small parts or hardware, please do not dispose of any contents until assembly is complete.
- Prior to starting assembly, use the parts and hardware lists to identify and separate each of the pieces included.
- Do not over-tighten screws or bolts.

TABLE OF CONTENTS

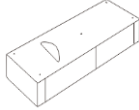
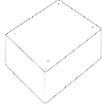
Parts List	Page 3
Hardware List	
Assembly Instructions	Page 5-6
Care & Maintenance	Page 7
Warnings	Page 7

PARTS LIST

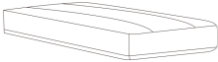
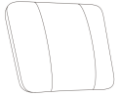
PART #	PICTURE	PART DESCRIPTION	INTERNAL #	LOCATION	QTY
A		Corner Legs	N/A	Pouch Underneath Sofa	12
B		Middle Support Leg	N/A	Pouch Underneath Sofa	1
C		Seat Frame	N/A	In Box	1
D		Ottoman Frame	N/A	In Box	1
E		Back Support	N/A	In Box	1
F		Big Ottoman	N/A	In Box	1
G		Seat Cushion of 3S	N/A	In Box	2
H		Chaise Cushion	N/A	In Box	1
I		Back Cushion	N/A	In Box	3

Thank you for your purchase. Be sure to check all packing material carefully for small parts which may have come loose inside the carton during shipment. Identify and count all parts and compare with the parts and hardware lists.

STEP 1

1. Flip over item C, D, & F and remove Corner Legs (A) and Middle Support Leg (B).
2. Attach Legs to pieces as shown below.

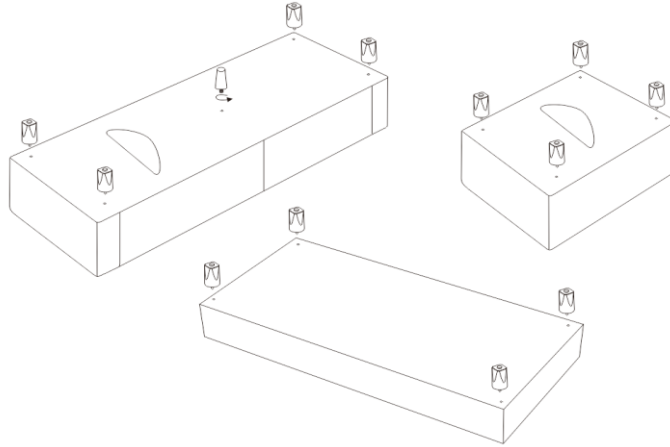

STEP 2

1. Attach the Back Support (E) to the frame as shown below.

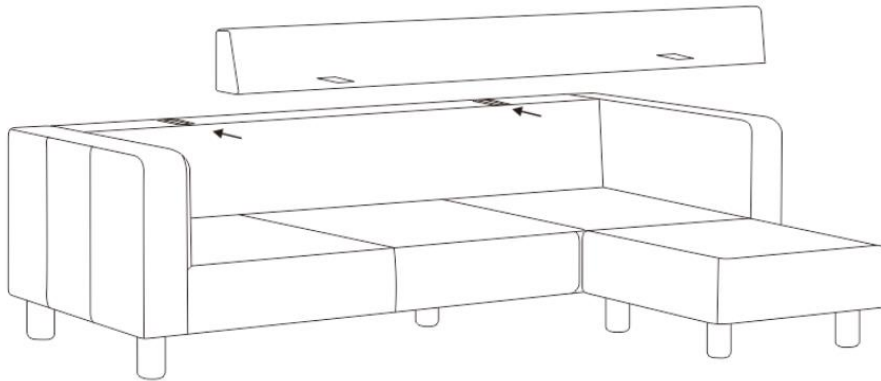

STEP 3

1. Set the Seat Cushion (G) and Back Cushion (I) on frame as shown below.

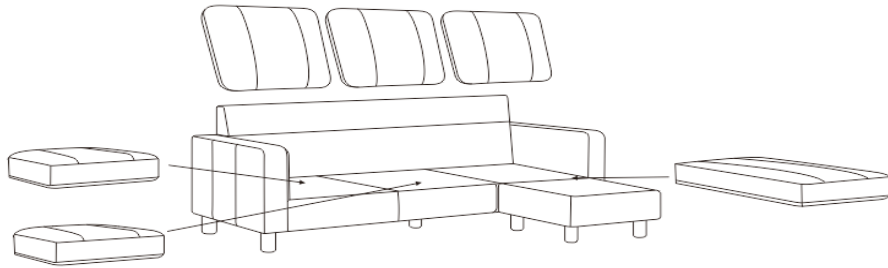

STEP 4

Assembly Complete

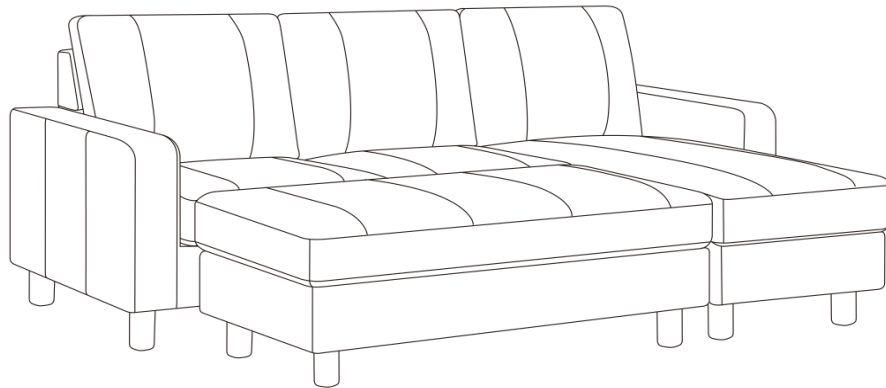



CARE & MAINTENANCE



Wood Care Tips

- Wood color can fade and/ or sun bleaching can occur when exposed to direct sunlight over a long period of time.
- Avoid placing your furniture in direct sunlight.
- Rearrange accessories over time to prevent spot bleaching.
- For daily maintenance, use clean and soft rags or cloths to wipe off dust on the surface along the grains.
- Never use damp rags or anything with a hard surface to rub onto the furniture.
- Always keep surfaces clear of any acid or chemical substances.
- To avoid damage refrain from stacking large and/or heavy objects on top of the furniture.
- Avoid cleaners which use chemical products. Many of these are harsh and not safe for use on upholstery.



CARE & MAINTENANCE



Leather Care Tips

- Fabric can fade when exposed to direct sunlight over a long period of time.
- To minimize fading, avoid placing your furniture in direct sunlight.
- Avoid cleaners which use chemical products. Many of these are harsh and not safe for use on upholstery.
- Stress to the fabric may result in tears and when stretched, upholstery may not completely return to its original shape.
- Avoid sitting in one area and use the seating areas evenly for even wear.
- Leather and fabric are not resistant to animals. Allowing pets on your upholstered furniture is not recommended.
- If pillow cushions are sewn to the frame, any pulling or tugging may result in a tear.



CARE & MAINTENANCE



Fabric Care Tips

- Be sure to vacuum on a weekly basis so dust and dirt do not settle into the fabric.
- Wrinkles in the fabric are a natural part of normal wear.
- Fabric can fade when exposed to direct sunlight over a long period of time.
- To minimize fading, avoid placing your furniture in direct sunlight.
- Avoid cleaners which use chemical products. Many of these are harsh and not safe for use on upholstery.
- Stress to the fabric may result in tears and when stretched, upholstery may not completely return to its original shape.
- Avoid sitting in one area and use the seating areas evenly for even wear.
- Fabric is not resistant to animals. Allowing pets on your upholstered furniture is not recommended.
- If pillow cushions are sewn to the frame, any pulling or tugging may result in a tear.



WARNING



- Do not use this product unless all screws and bolts are securely tightened.
- Check that all screws and bolts are secure every three months or as needed
- Dispose of packing material properly. Do not use plastic cover as head covering as it may cause suffocation.
- Do not use this product as a stepladder.
- Use this product for intended purpose only.
- Intended for residential use only.

*Thank you for bringing Abbyson into your home. We truly appreciate your business.
To discover more home furnishings that fit your style visit us at Abbyson.com.*