

Additional parts and accessories are available for purchase online at:  
[www.SevilleClassics.com](http://www.SevilleClassics.com)



**WEB106**  
8-Pack Shelf Label



**WEB090**  
Shelving Liners  
60" x 24" (2-Pack)



**SHE24609**  
UltraDurable Shelf  
60" x 24"

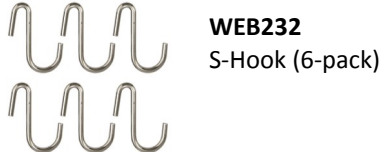

**WEB232**  
S-Hook (6-pack)



View assembly online here:  
<https://www.youtube.com/watch?v=N6iRVVqBG-I>

## Caution

- Place heavier items on the lower shelves and lighter ones on the top.
- Do not stand or climb on the shelving system.
- Do not drop heavy items on the system.
- Do not move the system while loaded.

## Specifications

Dimensions: 60" W x 24" D x 72" H (80" H on wheels), 1" Pole Diameter

Weight capacity	Per shelf	Overall
On leveling feet	<b>800 lbs.</b> (362.8 kg)	<b>4000 lbs.</b> (1814 kg)
On wheels	<b>100 lbs.</b> (45.3 kg)	<b>500 lbs.</b> (226.8 kg)

## Customer Service Information

Telephone: (800) 323-5565  
 Fax: (310) 533-3899  
 Hours: 8:30 AM – 4:30 PM (PST)  
 Email: [Support@SevilleClassics.com](mailto:Support@SevilleClassics.com)  
 Homepage: [www.SevilleClassics.com](http://www.SevilleClassics.com)

# ULTRADURABLE<sup>®</sup>

## MEGA RACK™ Commercial-Grade 5-Tier NSF Steel Wire Shelving with Wheels

60" W x 24" D x 72" H

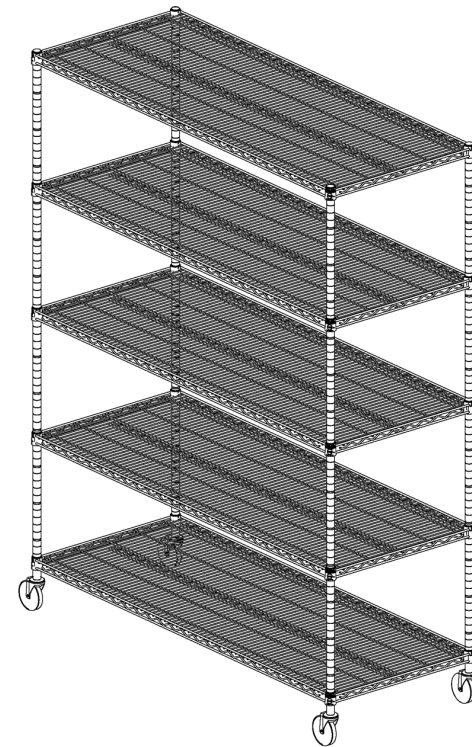





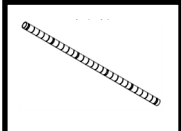

Model #: SHE24600

Thank you for choosing Seville Classics! We hope that you enjoy your commercial-grade steel wire shelving! Please read through this guide for parts list, assembly instructions, frequently asked questions and further contact information.

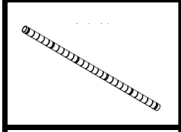
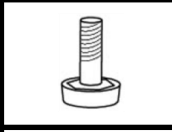
# Parts List

Please make sure you have all the parts on this list.

A. Bottom poles (4) (Threaded end)		E. Slip sleeves (20)	
B. Top poles (4) (Plastic cap on end)		F. Leveling feet (4)	
C. Connectors (4) (May be attached to poles)		G. Wheels (2)	
D. Shelves (5)		H. Locking wheels (2)	

If you're missing parts, contact us for replacements at (800) 323-5565 or send an email to [Support@SevilleClassics.com](mailto:Support@SevilleClassics.com)

## Assembly Instructions

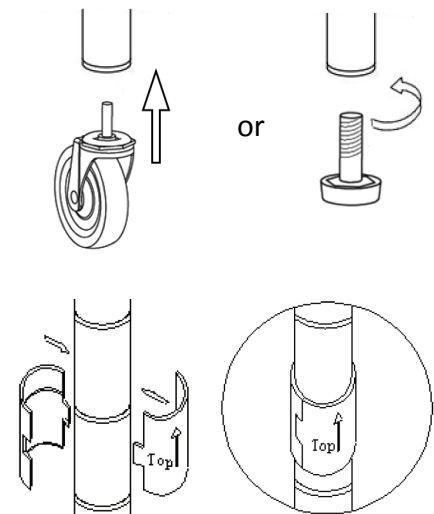

### STEP 1.

Firmly press **WHEELS (G, H)** into base of bottom poles until click is felt and heard. Or, screw **LEVELING FEET (F)** into poles until flush.

Repeat for all bottom poles.

### STEP 2.

Snap **SLIP SLEEVES (E)** around the grooves on **BOTTOM POLES (A)** for your lowest shelf.

**TIP!** Count the number of grooves from the bottom of the pole to keep the height consistent.

1

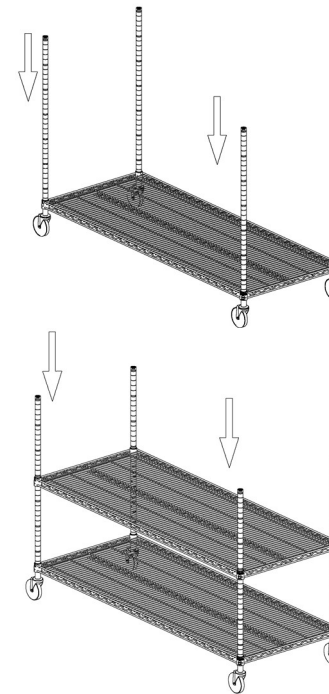

### STEP 3.

Fit **SHELF (D)** over the top of the 4 poles and over **SLIP SLEEVES (E)**.

Repeat **STEPS 2-3** for next shelf.

**TIP!** If necessary, lightly tap shelves into place with a rubber mallet.

### STEP 4.

Screw **CONNECTORS (C)** into top of **BOTTOM POLES (A)**.

Screw **TOP POLES (B)** to **CONNECTORS (C)**.

**TIP!** Connectors may be pre-installed.

### STEP 5.

Repeat **STEPS 2-3** for remaining shelves.

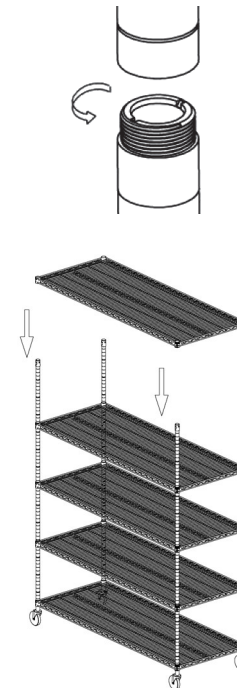

2

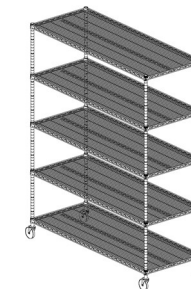

Congratulations!

Enjoy your now complete shelving unit.