



12-Sheet Micro-Cut Shredder

Operation Manual











Model C249-A



Please read thoroughly before operating this equipment

Please read this manual and become familiar with the safety information, operating instructions, and maintenance requirements. Following all warnings and instructions in this manual and as marked on the shredder. Do not attempt to service this unit by yourself. Doing so will void the manufacturer's warranty and may expose you to sharp cutting blades and/or high voltage electric shock that could cause serious injury. Any repairs must be performed by qualified service personnel.

Warning: IMPORTANT safety instructions

-  1. Warning:
Before switching the machine on, make sure that you observe all safety instructions
-  2. Read instructions before use
-  3. Avoid touching the document feed opening with hands
-  4. Avoid getting hair near the document feed opening
-  5. Product is not intended for use by children (product is not toy)
-  6. Do not spray or keep any aerosol products in or around shredder
-  7. Avoid loose clothing or jewelry touching the document feed opening
-  8. Sharp edges, do not touch
-  9. This equipment is not intended for use by children. Avoid touching the media feed opening with the hands, clothing or hair. Unplug this equipment when not in use of an extended period of time.
10. Keep in the OFF position when the shredder is not in use for prolonged periods of time.
11. Empty bin frequently.
12. The document shredder must always be deactivated and disconnected from the electrical line prior to moving, transporting and cleaning the device and prior to emptying the waste basket.
13. The device may not be operated with a damaged power cord.
14. For indoor use only.
15. To protect the machine well, we suggest the user to operate it in this way: work 30 minutes, then rest 20 minutes.
16. The machine allowed max shred 12 sheets 75gsm (20lbs.) paper or 1 Credit card  or 1CD  at one time.

17. The socket-outlet must be installed near the equipment and must be easily accessible during operation.
18. Please do not allow any plastic or metal foil to be shredded, as these types of material can damage the blades.

Overview

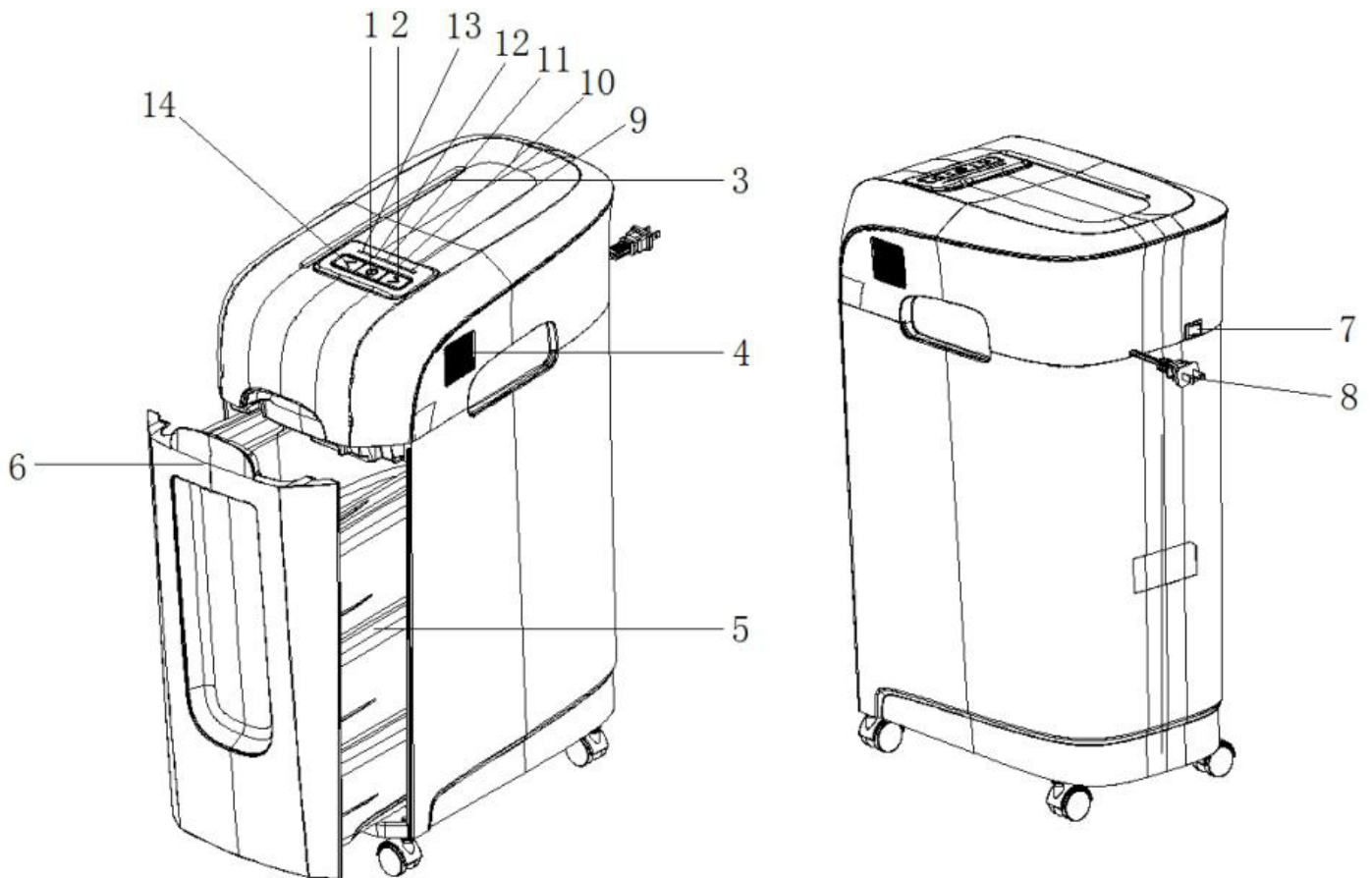

1. Standby and emergency stop button
2. Forward
3. Shredding slot
4. Vent
5. Bin

6. Handle of bin
7. Main switch
8. Power cord
9. Power on indicator
10. Overheat indicator

11. Overload indicator
12. Door open indicator
13. Bin full indicator
14. Reverse

Installation and operation

- Place the equipment on a flat and even surface.
- Make sure that the equipment is placed away from any radiators or hot areas.
- Do not cover the cooling vent at the rear of the equipment.
- Avoid the use of extension cables and multiple power sockets if possible and connect the equipment directly to a wall socket (as specified in the section on technical information).
- Please keep the equipment at a distance of at least 10cm / 4" away from the wall in order to ensure the cooling vent has an adequate supply of air.
- Please keep the bin positioned perfectly.

Operation:

Turn on the main powerswitch at the rear of the machine to "I" position. The equipment is now ready to use. If the power on indicator does not light up, please refer to the section "General Troubleshooting" on page 7 of this manual.

Auto "⏻" position

Place the paper in portrait orientation into the corresponding in feed unit. The paper will be recognized by the photo sensor, and the blades will begin to feed the paper through automatically. The equipment will stop once again after a short period when no paper has passed through the cutter. After shredding is completed, you can press "⏻" to switch from operation mode into standby and have a minimal power consumption.

Please press the "⏻" button again to switch back from standby to operational mode.

Please be aware of the maximum shredding capacity of machine is 12 sheets 75gsm (20lbs. weight) paper.

Forward " > " position

When you keep pressing the ">" button, the blades will run to forward; if you release the button, blades will stop running. We recommend that you only use ">" button to make sure that the remaining paper in slot gets shredded or you want to clear the slot.

Reverse " < " position

When you keep pressing the "<" button, the blades will run in reverse. After you release the button, the blades will stop running. The purpose of this button is to rectify a paper jam. In this case, the direction of the shredding operation is reversed before the work cycle ends in order to free the shredding blades.

Overload

If you overload more paper than the machine is capable of handling, the overload indicator will turn to red continuously. The blades will run in reverse automatically and remove the jammed paper. Reduce the number of sheets and try again. The machine will work if the overload indicator light is off. If this particular fault is not rectified automatically, please press the "<" button in order to remove any paper.

The machine will then be reset to operational mode.

Overheat

It is possible that the engine may overheat if you exceed the maximum amount of time specified for continuous operation. In this case, the blades will stop and the overheat indicator will turn to red continuously while the machine starts to cool down. Please don't pull out the bin during this period.

The machine can be used again when the overheat indicator light turns off.

Bin full

If the bin full indicator turns to red continuously, the blades will stop immediately. If this happens, please pull out the bin and empty it, then place bin back in, and the machine will then be reset to either normal or standby mode.

Door open

When you pull out the bin, the door open indicator will turn to red continuously, and the blades will stop immediately. After placing the bin back in, the machine will then be reset to either normal or standby mode.

Manual in feed

If one sheet of paper is too thin or too transparent for it to be recognized by the photo sensor, please press the ">" button. You can also use the ">" and "<" buttons to allow any excess sheets of paper to be shredded.

Remove excess paper

Switch off the equipment, and disconnect the power supply to remove any snippets of paper which have become stuck to the blades. The blades are very sharp, so please be extra careful!

After the paper snippets are cleaned up, please connect the power cable, and switch on the power again. You can now use the machine once again.

Product specification

Model	Unit dimensions (mm)	Shred type	Cutting size (mm)	Max. Shred capacity	Slot width	Voltage/current	Bin capacity (L)	Unit Weight	Noise Level
C249-A	350x235x539	Micro Cut	4x12	12 sheets 75gsm(20lbs.) paper/1 CD/1 Credit card	220mm	120V~, 60Hz /3.5A	17L	7.7kg	65dB

Warranty claims

Contrary to expectations, please be aware of the following should the equipment not function correctly:

The Member's Mark 12 Sheet Micro-Cut Shredder warranty period shall last 1 year from date of purchase for the unit and 3 years for the blade assembly (subject to correct usage requirements). Please keep your proof of purchase and the original packaging. The proof of purchase serves as evidence of the warranty claim. This warranty shall only apply to any material or manufacturing defects, but not to any damage to fragile components, i.e. the casing. Any equipment which has been damaged by improper use beyond the guidelines shall not be covered. A warranty shall be void if any repairs have been carried out without the explicit consent of our customer service team. Many thanks for your understanding!

General troubleshooting

Error	Troubleshooting	Resolution
Machine is not Functioning	Is the power supply and socket connected to the wall correctly?	Adjust the connections.
	Is the bin positioned correctly? Is the door open indicator turned to red continuously?	Adjust the position of bin until the door open indicator light turns off, then try again.
	Is the power cable damaged?	Contact after-sales call center by the hotline: 888-301-0332 Mon - Fri (8AM - 5PM CST)
	Is the bin full? Is the bin full indicator turn to red continuously?	Pull out the bin and empty it, place bin back in, then try again.
	Is the engine possibly overheating? Is the overheat indicator turn to red continuously?	Wait until the machine has cooled down, and overheat indicator light turns off, then try again.
	Is the sheet of paper too thin for it to be detected by the sensors?	Fold the sheets of paper and try again.
	Do you want to shred excessive amounts of paper at once? Is the overload indicator turned to red continuously?	Reduce the amount of paper(not exceed the claimed 12sheets) and try again, until the overload indicator light turns off.
Blades are blocked	Is the paper jammed?	Press the " < " button and remove any excess paper.
Blades will not stop	Excess paper or unusual objects are blocking the photo sensor?	Remove any excess paper or unusual objects which blocked the photo sensor, then try again.
Machine sounds too loud	Is the surface uneven? Is the equipment in a straight position?	Place the machine on a flat surface.

Should the instructions above not help to resolve the issue, then please contact our after-sales call center through following ways:

1. Call the hotline number: 888-301-0332 (Mon - Fri, 8AM - 5PM CST)
2. Visit our Website for help

Questions or Comments?

We would love to hear about your Member's Mark experience! Visit us at:
samsclub.com/membersmarkhelp

Equipment maintenance and cleaning

As the blades are very sharp and the engine is particularly powerful, you should take the appropriate precautions when using the equipment on a daily basis to ensure that any items of clothing, ties, scarves and hair do not fall into the equipment!

The bin must be regularly checked and emptied regularly to ensure it is able to operate smoothly. Do not allow any item of clothing, plastic, or metal fragments to fall into the blades.

It is advised to use the number of sheets of paper below the claimed capacity (12 sheets 20lbs. weight paper) in order to achieve a long-life expectancy.

Wear or damage to the shredder can decrease the reliability of the data destruction, so please check from time to time, the size of the material particles.

You must disconnect the plug first when cleaning the equipment. It must then be cleaned on the outside by using a cloth and mild soap solution. The cloth should only be damp and not wet. Avoid any liquids from penetrating into the blades. Do not use high-pressure air spray, bleach, alcohol, paint stripper, or any other flammable liquids under any circumstances.

Packaging contents

Item	Paper shredder	User manual
Quantity	1	1

FCC statement

This device complies with part 15 of the FCC Rules. Operation is subject to the following two conditions: (1) This device may not cause harmful interference, and (2) this device must accept any interference received, including interference that may cause undesired operation.

Changes or modifications not expressly approved by the party responsible for compliance could void the user's authority to operate the equipment.

NOTE: This equipment has been tested and found to comply with the limits for a Class B digital device, pursuant to part 15 of the FCC Rules. These limits are designed to provide reasonable protection against harmful interference in a residential installation. This equipment generates, uses and can radiate radio frequency energy and, if not installed and used in accordance with the instructions, may cause harmful interference to radio communications. However, there is no guarantee that interference will not occur in a particular installation. If this equipment does cause harmful interference to radio or television reception, which can be determined by turning the equipment off and on, the user is encouraged to try to correct the interference by one or more of the following measures:

- Reorient or relocate the receiving antenna.
- Increase the separation between the equipment and receiver.
- Connect the equipment into an outlet on a circuit different from that to which the receiver is connected.
- Consult the dealer or an experienced radio/TV technician for help.

